

INTEX® OWNER'S MANUAL

English

368
IO

RECHARGEABLE HANDHELD VACUUM

Model CL1004 MAX. WATER TEMPERATURE 35 °C

READ AND FOLLOW ALL INSTRUCTIONS BEFORE USING THIS PRODUCT



WARNING

- Assembly and disassembly by adults only. This is not a toy.
- This appliance can be used by children aged from 8 years and above and persons with reduced physical, sensory or mental capabilities or lack of experience and knowledge if they have been given supervision or instruction concerning use of the appliance in a safe way and understand the hazards involved.
- Children shall not play with the appliance. Cleaning and user maintenance shall not be made by children without supervision.
- The appliance must only be supplied at safety extra low voltage corresponding to the marking on the appliance.
- Do not use if unit is damaged in any way. Replace damaged components promptly.
- This vacuum creates suction. Keep hair, loose clothing, fingers, and any body parts away from openings and moving parts.
- Use only accessories and replacement parts specified in this manual.
- Never leave this product plugged into the main outlet for long term storage.
- Never leave this product in the water when it is OFF or has run out of battery power.
- Do not use this product for pool opening (start of the season). This product is design for routine general maintenance of your pool or spa. Do not use for cleaning of longer accumulated heavy dirt such as at the start of the pool season.
- This product is designed for underwater use: must be submerged to operate properly. Do not use this product as an all-purpose vacuum cleaner.
- Do not use this product without the filter bag and/or vacuum body cover.
- Do not vacuum sharp objects, as this may damage the filter bag.
- Do not vacuum toxic substances, flammable or combustible liquids such as gasoline, or operate in the presence of explosive or flammable fumes.
- Never insert or drop objects into any opening on the device. Keep all openings free of leaves, debris, or anything that may reduce the water flow.
- Always turn off and unplug the device before cleaning, servicing, changing the filter bag or any routine maintenance.
- Keep the charging USB cable away from sharp objects and hot surfaces.
- Do not charge the product with a damaged charging USB cable and/or a damaged plug charger.
- Charge the product indoors in a clean and dry place. Do not expose to rain or extreme temperature and do not handle with wet hands during charging. Never charge the product while operating it.
- This product contains sealed non-replaceable nickel metal-hydride (Ni-MH) rechargeable batteries. Do not dispose of the product in regular trash, municipal waste stream or by fire as the built-in rechargeable battery may leak or explode. Always dispose of the batteries safely in accordance with your local law and regulations.
- This product is intended to be used only for the purposes described in the manual.
- Charging operations shall be carried out in accordance with the instructions in "Charging the Battery" section.

FOLLOW THESE RULES AND ALL INSTRUCTIONS TO AVOID PROPERTY DAMAGE OR OTHER INJURY.

SAVE THESE INSTRUCTIONS

PARTS LIST

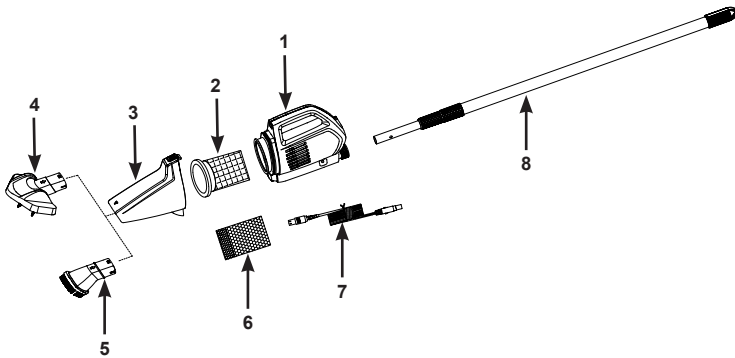
368
IO

NOTE: Drawings for illustration purpose only. Actual product may vary. Not to scale.

REF. NO.	DESCRIPTION	QTY.	SPARE PART NO.
1	VACUUM BODY WITH NON-REPLACEABLE BATTERY	1	13349
2	FILTER BAG WITH GASKET	1	13268
3	VACUUM BODY COVER	1	13353
4	LARGE VACUUM BRUSH HEAD	1	13351
5	VACUUM NOZZLE	1	13352
6	MICRO-FILTER BAG	1	13253
7	VACUUM CHARGING USB CABLE	1	12269
8	TELESCOPING ALUMINUM POLE	1	13350

General:

- Plug charger not included. Only use a compatible standard female USB (smartphone or tablet) plug charger with an output voltage of 5.0-5.2V $\overline{\text{---}}$, 1A or more.
- A full charge takes about 5-6 hours: provides about 40-50 minutes of operation.
- Make sure the charging receptacle on the product is dry before any recharging.

Charging the Battery:

1. Connect USB cable to plug charger USB receptacle and plug the charger into the main electrical outlet.
2. Connect the small end of the USB cable (7) into the vacuum body (1) charging receptacle. See fig 1. The indicator light will turn red at this time. When fully charged, the indicator light will turn green. See fig 2.

Note: For the first time use or after a long term storage, the device must be charged for 6 hours before using it.

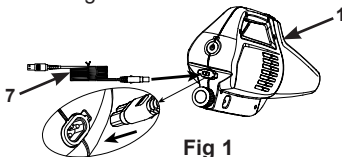

Fig 1

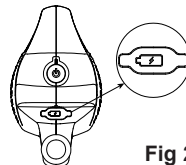

Fig 2

SAVE THESE INSTRUCTIONS

Installation:

1. Insert the filter bag with gasket (2) into the vacuum body (1). See fig 3.1. For vacuuming fine-small particles: insert the micro-filter bag (6) into the filter bag with gasket (2), making sure the micro-filter bag "wraps over" the filter bag gasket (2). Then place the entire filter bag with the micro-filter bag into the vacuum body. See fig 3.2.
2. Install the vacuum body cover (3) onto the vacuum body (1). See fig 3.3.
Note: When removing the vacuum body cover (3), press the spring button to release the vacuum body cover.

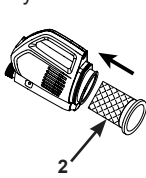

Fig 3.1

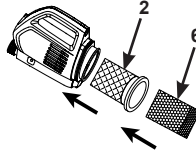

Fig 3.2

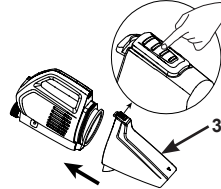

Fig 3.3

3. Attach the desired cleaning head accessory to the vacuum body cover. See fig 4.
Note: Make sure the arrow on the vacuum body cover (3) matches the arrow on the vacuum brush head (4) or vacuum nozzle (5).

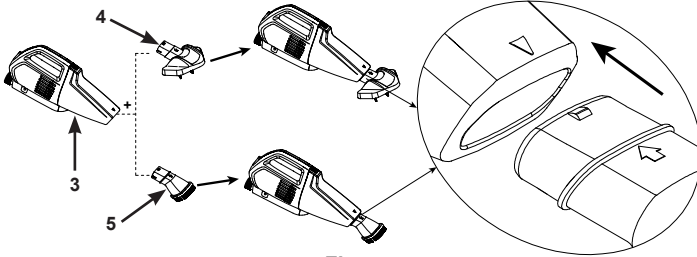

Fig 4

4. Attach the aluminum pole (8) by squeezing the spring buttons and inserting into handle of the vacuum body (1). Check the buttons "pop" into the holes. Adjust the length of the shaft by unlocking, extending and locking each section accordingly. See fig 5.

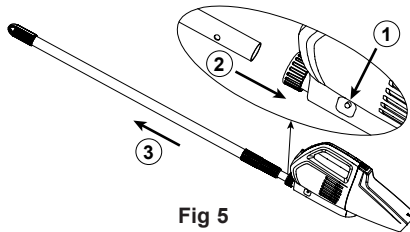

Fig 5

IMPORTANT

The vacuum body will not operate unless it is submerged in water. Water flow from sides of the vacuum body indicates the product is working.

SAVE THESE INSTRUCTIONS

368
IO

Operation:

1. Make sure the charging receptacle is securely covered with the rubber flap first. Press the power button first, the battery indicator light will turn on. Then place the vacuum in the water. Please note that if the battery has no power, the vacuum motor will stop working, but the indicator light will still be on. At this point you must recharge the battery. See fig 6.

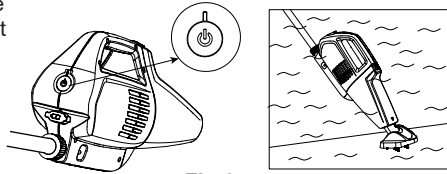

Fig 6

Note: Always turn off the power button when the device is not in use or during long term storage in order to prevent damage to the battery.

2. Carefully “sweep” the surface of the spa or pool to remove debris.
3. Check and empty the filter bag/micro-filter bag regularly during and after each use.
4. Reverse the above installation steps to remove and empty the filter bag/micro-filter bag.

Note: Rinse vacuum body, cover and filter bags with a garden hose before reassembling.

Maintenance and long term storage:

1. Turn off the vacuum before cleaning, servicing and maintenance. Regularly check all components for sign of damage. Discard and replace damaged components immediately.
2. Using the installation instructions in reverse, disassemble the vacuum. Clean all the components with water, and make sure all components are thoroughly dry before storage.
3. Store the product and accessories in a dry, temperature controlled, between 0° – 40°C (32° – 104°F), storage location.
4. To protect and extend the life of the battery, make sure the battery is charged before long term storage, and charge the battery every 3 months thereafter.
5. The original packing can be used for storage.

TROUBLE	SOLUTION
VACUUM DOESN'T WORK	<ul style="list-style-type: none"> • Charge the product then turn on the unit. Ensure the power button is on. • Keep the vacuum body under the water.
LOW SUCTION	<ul style="list-style-type: none"> • Choose the suitable bag for filtering and install the filter bag(s) correctly. • Check and empty the filter bag(s) regularly during and after each use. • Check for any sand or deposits in the vacuum. • Check if the battery power is too low. If it is too low, recharge it. • Contact Intex Service Center.
CHARGING FAILED	<ul style="list-style-type: none"> • Plug the charger (not included) into the main electrical outlet first, then connect the USB cable into the vacuum body charging receptacle. • Ensure the charger cable is securely inserted into the charging receptacle, the indicator light should be on.
DOESN'T CLEAN THE POOL	<ul style="list-style-type: none"> • Check if the battery power is too low. If it is too low, recharge it. • Use the correct vacuum head: use the large vacuum brush head for flat open surfaces, and the vacuum nozzle head for corners, steps and uneven surfaces. • Use the correct filter bag, see “Installation” section. • Ensure the vacuum head or nozzle is close to the surface of the wall or floor, and reduce the sweeping movement and speed during vacuuming. • The bristles of the vacuum brush head are worn out, replace a new brush head. • For heavy stains on the pool wall, it's recommended emptying the pool and scrub the wall with mild detergent.

SAVE THESE INSTRUCTIONS

Limited Warranty

368
IO

Your RECHARGEABLE HANDHELD VACUUM has been manufactured using the highest quality materials and workmanship. All Intex products have been inspected and found free of defects prior to leaving the factory. This Limited Warranty applies to the RECHARGEABLE HANDHELD VACUUM only.

This limited warranty is in addition to, and not a substitute for, your legal rights and remedies. To the extent that this warranty is inconsistent with any of your legal rights, they take priority. For example, consumer laws across the European Union provide statutory warranty rights in addition to the coverage you receive from this limited warranty: for information on EU-wide consumer laws, please visit the European Consumer Center website at http://ec.europa.eu/consumers/ecc/contact_en/htm.

The provisions of this Limited Warranty apply only to the original purchaser and are not transferable. This Limited Warranty is valid for a period of one (1) year from the date of the initial retail purchase. Keep your original sales receipt with this document, as proof of purchase will be required and must accompany warranty claims or the Limited Warranty will be invalid.

If you find a manufacturing defect in the RECHARGEABLE HANDHELD VACUUM during the warranty period, please contact the appropriate Intex Service Center listed in the separate "Authorized Service Centers" sheet. If the item is returned as directed by the Intex Service Center, the Service Center will inspect the item and determine the validity of the claim. If the item is covered by the provisions of the warranty, the item will be repaired or replaced, with the same or comparable item (at Intex's choice) at no charge to you.

Other than this warranty, and other legal rights in your country, no further warranties are implied. To the extent possibly in your country, in no event shall Intex be liable to you or any third party for direct or consequential damages arising out of the use of your RECHARGEABLE HANDHELD VACUUM, or Intex or its agents' and employees' actions (including the manufacture of the product). If your country does not allow the exclusion or limitation of incidental or consequential damages, this limitation or exclusion does not apply to you.

You should note that this limited warranty does not apply in the following circumstances:

- If the RECHARGEABLE HANDHELD VACUUM is subject to negligence, abnormal use or application, accident, improper operation, improper voltage or current contrary to operating instructions, improper maintenance or storage;
- If the RECHARGEABLE HANDHELD VACUUM is subject to damage by circumstances beyond Intex's control, including but not limited to, ordinary wear and tear and damage caused by exposure to fire, flood, freezing, rain, or other external environmental forces;
- To parts and components not sold by Intex; and/or.
- To unauthorized alterations, repairs or disassembly to the RECHARGEABLE HANDHELD VACUUM by anyone other than Intex Service Center personnel.

Injury or damage to any property or person is not covered by this warranty.

Read the owner's manual carefully and follow all instructions regarding proper operation and maintenance of your RECHARGEABLE HANDHELD VACUUM. Always inspect your product prior to use. This limited warranty will be void if use instructions are not followed.

©2023 Intex Marketing Ltd. - Intex Development Co. Ltd. - Intex Recreation Corp. All rights reserved/Tous droits réservés/Todos los derechos reservados/Alle Rechte vorbehalten. Printed in China/Imprimé en Chine/Impreso en China/Gedruckt in China.

®™ Trademarks used in some countries of the world under license from®™ Marques utilisées dans certains pays sous licence de/Marcas registradas utilizadas en algunos países del mundo bajo licencia de/Warenzeichen verwendet in einigen Ländern der Welt in Lizenz von/Intex Marketing Ltd. to/ a/a/an Intex Development Co. Ltd., Hong Kong & Intex Recreation Corp., P.O. Box 1440, Long Beach, CA 90801 • Distributed in the European Union by/Distribué dans l'Union Européenne par/Distribuido en la Unión Europea por/Ventrib in der Europäischen Union durch/Intex Trading B.V., Ettenseweg 46, 4706 PB Roosendaal - The Netherlands • Distributed in the UK by Unitex Service (UK) Limited, 21 Holborn Viaduct, London EC1A 2DY, UK. www.intexcorp.com

INTEX®

SAVE THESE INSTRUCTIONS